

**SANSICO**<sup>™</sup>

**HANSEN**<sup>™</sup>

Complies to BS EN 1253:2003, Class K3

# TOP ACCESS FLOOR TRAP SYSTEM

# S4

# WORKS BETTER & LOOKS SIMPLER



## LUXURIOUS GRATINGS & COLLARS

Quality without Compromise



Print Edition for March 2024

# Introduction



## Sansico Industries Sdn Bhd

For over 20 years now, Sansico Industries Sdn Bhd has accumulated a healthy and strong market reputation of providing quality products to customers. We have since progressed to be one of the leading manufacturers for cold water plumbing systems and as well as top access floor trap systems for wastewater management.



**Sansico™** launched its first top access floor traps in 2008 and won the new product award for our S1 & S2 models in the prestigious ARCHIDEX 2009. And in the year 2017 we won another new product award again for our innovative 360-aligning collar in the ARCHIDEX 17 exhibition. Our floor trap systems have been successfully and widely used in condominiums/houses, hospitals, commercial buildings, offices, hypermarkets and in overseas i.e., Singapore, Indonesia, Thailand, Cambodia & Vietnam.

With entrepreneurial thinking, we have revolutionised our floor trap design to eliminate all problems faced by the top access floor traps in the market. Thus, we proudly present our latest patented state of the art - **S4 model**. The SIRIM approved S4 has overcome all the shortcomings of a top access floor trap system. With its elegant and sleek design, it has an additional feature called “Zero Water Seal” that solves the fast dried-up water seal issue. To add icing on the cake, it comes with the largest range of locally manufactured quality floor gratings in the market. This allows for flexibility and many architecturally pleasing top finishing designs in the bathroom.

# Top Access Floor Trap System

## S4 Model

**Flow rate: 80 litres per minute** \*Sirim requirement: 48 litres / minute

Dimensions of **S4 Model** Top Access Floor Trap System 4" Pipe Sleeve

The S4 Floor Trap System can function normally with or without Water Seal

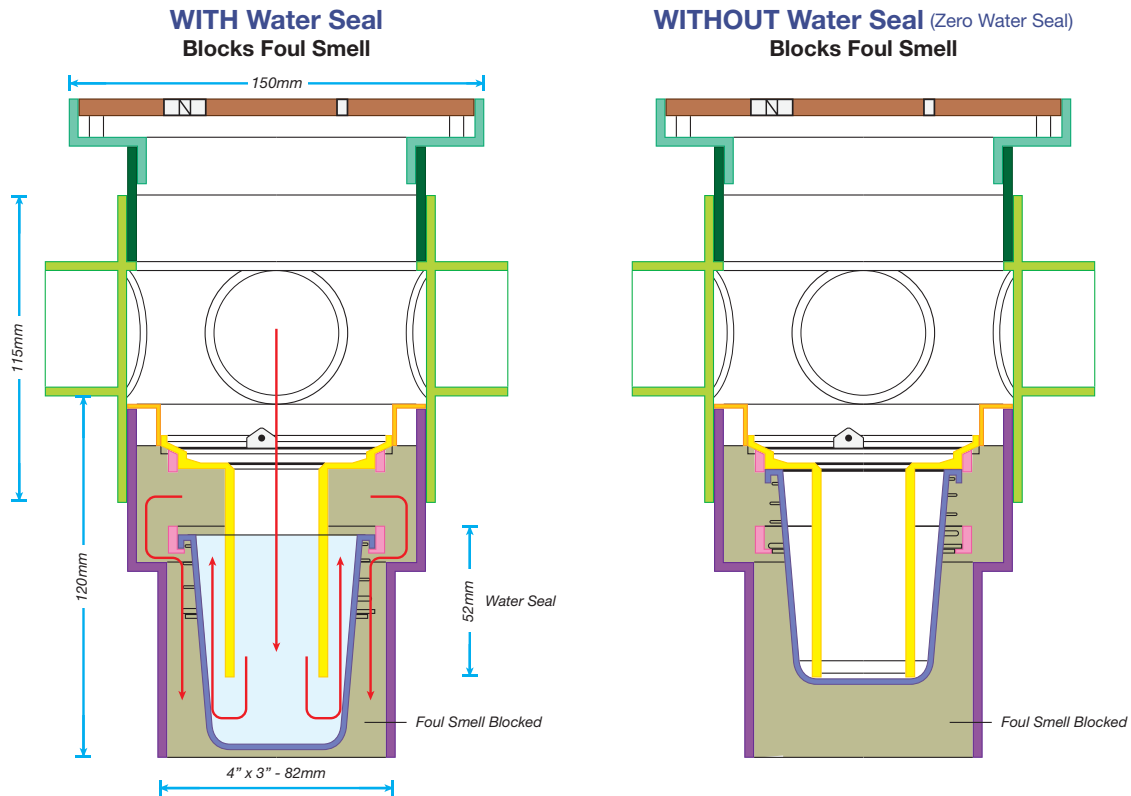

## Tests undergone by the SANSICO™ S4 Floor Trap/Gulley



- Load Test
- Depth of Water Seal
- Resistance of Water Seal to Pressure
- Access for Cleaning
- Anti Blockage
- Temperature Cycling
- Odour Tightness
- Water Tightness
- Flow Rate Test

### Benefits of S4 Trap system:

- Zero Water Seal -> This additional feature will activate when the water seal is fully evaporated
- Compact and elegant design
- Prevents foul smell and insects from entering the house
- Easy top access cleaning and maintenance
- Higher false ceiling, space saving
- 75mm opening for easy rodding & cleaning
- Comes with built-in sockets/inlets that provide quick connection for air conditioner & washing machine drain pipes to trap body (pipe sleeve)
- Air conditioner condensation water isolated
- Durable stainless steel 304 spring up to 300,000 cycles/strokes



### S4 Trap System Product Code

Bucket Trap	Trap Body	Outlet
 S4-BT	 S3-TBIN	 S4-OL4X3

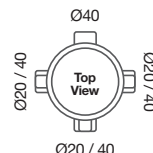



# 6" & 4" Grating & Collar

## Web / Round / Fish / Blank



**4" Web-1**

-  **Plastic Grating**  
S1-GP-W
-  **Standard Plastic Collar**  
S3/SF-CP4-W





**4" Web-1**  
c/w Washing Machine Hose Opening + Plastic Plug

-  **Plastic Grating**  
S1-GP-W-32PP
-  **Standard Plastic Collar**  
S3/SF-CP4-W





**6" Web-2**

-  **Plastic Grating**  
GP-W
-  **Standard Plastic Collar**  
S3/SF-CP-6P
-  **360° Aligning Collar**  
S3/SF-ACP-6P



**6" Web-2**  
c/w Washing Machine Hose Opening + Plastic Plug

-  **Plastic Grating**  
GP-W-32PP
-  **Standard Plastic Collar**  
S3/SF-CP-6P
-  **360° Aligning Collar**  
S3/SF-ACP-6P





**6" Round-2**

-  **Stainless Steel Grating**  
GSS-R
-  **Stainless Steel Collar**  
S3/SF-CSS-R





**6" Round-2**  
c/w Washing Machine Hose Opening + SS Plug

-  **Stainless Steel Grating**  
GSS-R-32SSP
-  **Stainless Steel Collar**  
S3/SF-CSS-R



**6" Fish-2**

-  **Stainless Steel Grating**  
GSS-F
-  **Stainless Steel Collar**  
S3/SF-CSS-R





**6" Stainless Steel Blank-2**  
c/w Washing Machine Hose Opening + SS Plug

-  **Stainless Steel Grating**  
GSS-B-32SSP
-  **Standard Plastic Collar**  
S3/SF-CP-6SS-G (Grey)  
S3/SF-CP-6SS-W (White)
-  **360° Aligning Collar**  
S3/SF-ACP-6SS-G (Grey)  
S3/SF-ACP-6SS-W (White)



**6" Plastic Blank-2**

-  **Plastic Grating**  
GP-B
-  **Standard Plastic Collar**  
S3/SF-CP-6P
-  **360° Aligning Collar**  
S3/SF-ACP-6P





# 6" & 4" Grating & Collar

## Tile Tray



**6" Stainless Steel Tile Tray & Collar**

-  **Stainless Steel Tile Tray**  
TSS-TT6
-  **Standard Plastic Collar with SS Lining**  
S3/SF-CPSSL-TT-G (Grey)  
S3/SF-CPSSL-TT-W (White)
-  **360° Aligning Collar**  
S3/SF-ACPSSL-TT-G (Grey)  
S3/SF-ACPSSL-TT-W (White)



**6" Stainless Steel Tile Tray with Plastic Collar**

-  **Stainless Steel Tile Tray**  
TSS-TT6
-  **Standard Plastic Collar**  
S3/SF-CP-TT-G (Grey)  
S3/SF-CP-TT-W (White)
-  **360° Aligning Collar**  
S3/SF-ACP-TT-G (Grey)  
S3/SF-ACP-TT-W (White)





**6" Plastic Tile Tray & Collar White**

-  **Plastic Tile Tray**  
TP-TT6-W
-  **Standard Plastic Collar**  
S3/SF-CP-TT-W
-  **360° Aligning Collar**  
S3/SF-ACP-TT-W





**6" Plastic Tile Tray & Collar Grey**

-  **Plastic Tile Tray**  
TP-TT6-G
-  **Standard Plastic Collar**  
S3/SF-CP-TT-G
-  **360° Aligning Collar**  
S3/SF-ACP-TT-G





**4" Stainless Steel Tile Tray & Collar**

-  **Stainless Steel Tile Tray**  
TSS-TT4
-  **Standard Plastic Collar with SS Lining**  
S3/SF-CPSSL-TT4-G (Grey)  
S3/SF-CPSSL-TT4-W (White)



**4" Plastic Tile Tray & Collar White**

-  **Plastic Tile Tray**  
TP-TT4-W
-  **Standard Plastic Collar**  
S3/SF-CP-TT4-W



**4" Plastic Tile Tray & Collar Grey**

-  **Plastic Tile Tray**  
TP-TT4-G
-  **Standard Plastic Collar**  
S3/SF-CP-TT4-G

# 6" Grating & Collar

## Maze / Planar



**6" Maze-2**

- Stainless Steel Grating**  
GSS-M
- Stainless Steel Collar**  
S3/SF-CSS-S



**6" Maze-2**

c/w Washing Machine Hose Opening + SS Plug

- Stainless Steel Grating**  
GSS-M-32SSP
- Stainless Steel Collar**  
S3/SF-CSS-S



**6" Maze-2 White**

- Plastic Grating**  
GP-M-W
- Standard Plastic Collar**  
S3/SF-CP-M1-W
- 360° Aligning Collar**  
S3/SF-ACP(SSL)-TT-W

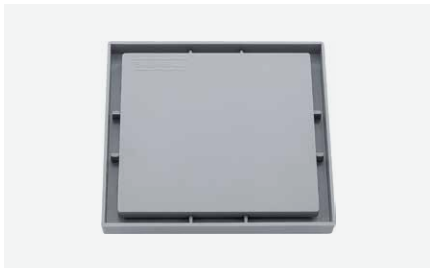

**6" Maze-2 Grey**

- Plastic Grating**  
GP-M-G
- Standard Plastic Collar**  
S3/SF-CP-M1-G
- 360° Aligning Collar**  
S3/SF-ACP(SSL)-TT-G

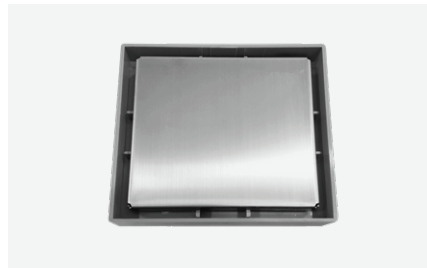

**6" Planar Short-2**

- Stainless Steel Grating**  
GSS-PS
- Standard Plastic Collar**  
S3/SF-CP(SSL)-TT-G (Grey)  
S3/SF-CP(SSL)-TT-W (White)
- 360° Aligning Collar**  
S3/SF-ACP(SSL)-TT-G (Grey)  
S3/SF-ACP(SSL)-TT-W (White)

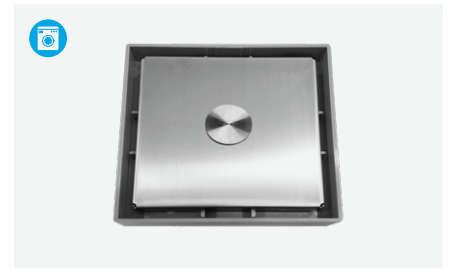

**6" Planar Short-2**

c/w Washing Machine Hose Opening + SS Plug

- Stainless Steel Grating**  
GSS-PS-32SSP
- Standard Plastic Collar**  
S3/SF-CP(SSL)-TT-G (Grey)  
S3/SF-CP(SSL)-TT-W (White)
- 360° Aligning Collar**  
S3/SF-ACP(SSL)-TT-G (Grey)  
S3/SF-ACP(SSL)-TT-W (White)



**6" Planar Tall-2**

- Stainless Steel Grating**  
GSS-PT
- Standard Plastic Collar with SS Lining**  
S3/SF-CPSSL-TT-G (Grey)  
S3/SF-CPSSL-TT-W (White)
- 360° Aligning Collar**  
S3/SF-ACPSSL-TT-G (Grey)  
S3/SF-ACPSSL-TT-W (White)



**6" Planar Tall-2**

c/w Washing Machine Hose Opening + SS Plug

- Stainless Steel Grating**  
GSS-PT-32SSP
- Standard Plastic Collar with SS Lining**  
S3/SF-CPSSL-TT-G (Grey)  
S3/SF-CPSSL-TT-W (White)
- 360° Aligning Collar**  
S3/SF-ACPSSL-TT-G (Grey)  
S3/SF-ACPSSL-TT-W (White)

# 6" & 4" Grating & Collar

## Daisy



**6" Daisy Square-2**

- ✱ **Stainless Steel Grating**  
GSS-DS
- **Standard Plastic Collar**  
S3/SF-CP-6SS-G (Grey)  
S3/SF-CP-6SS-W (White)
- **360° Aligning Collar**  
S3/SF-ACP-6SS-G (Grey)  
S3/SF-ACP-6SS-W (White)



**6" Daisy Square-2**  
c/w Washing Machine Hose Opening + SS Plug

- ✱ **Stainless Steel Grating**  
GSS-DS-32SSP
- **Standard Plastic Collar**  
S3/SF-CP-6SS-G (Grey)  
S3/SF-CP-6SS-W (White)
- **360° Aligning Collar**  
S3/SF-ACP-6SS-G (Grey)  
S3/SF-ACP-6SS-W (White)



**6" Daisy Square-2 Anti-Theft**

- ✱ **Stainless Steel Grating**  
GSS-DS-AT
- **Standard Plastic Collar**  
S3/SF-CP-6SS-G (Grey)  
S3/SF-CP-6SS-W (White)
- **360° Aligning Collar**  
S3/SF-ACP-6SS-G (Grey)  
S3/SF-ACP-6SS-W (White)

\*2 nos Cross Head SS Screws Included



**6" Daisy Square-4**

- ✱ **Stainless Steel Grating**  
GSS-DS4
- **Stainless Steel Collar**  
S3/SF-CSS-S



**6" Daisy Square-4**  
c/w Washing Machine Hose Opening + SS Plug

- ✱ **Stainless Steel Grating**  
GSS-DS4-32SSP
- **Stainless Steel Collar**  
S3/SF-CSS-S



**6" Daisy Square-4 Anti-Theft**

- ✱ **Stainless Steel Grating**  
GSS-DS4-AT
- **Stainless Steel Collar**  
S3/SF-CSS-S-AT

\*2 nos Allen Key SS Screws Included



**6" Daisy Square-3**

- ✱ **Stainless Steel Grating**  
GSS-DS3
- **Standard Plastic Collar with SS Lining**  
S3/SF-CPSSL-G (Grey)  
S3/SF-CPSSL-W (White)
- **360° Aligning Collar**  
S3/SF-ACPSSL-G (Grey)  
S3/SF-ACPSSL-W (White)



**6" Daisy Square-3**  
c/w Washing Machine Hose Opening + SS Plug

- ✱ **Stainless Steel Grating**  
GSS-DS3-32SSP
- **Standard Plastic Collar with SS Lining**  
S3/SF-CPSSL-G (Grey)  
S3/SF-CPSSL-W (White)
- **360° Aligning Collar**  
S3/SF-ACPSSL-G (Grey)  
S3/SF-ACPSSL-W (White)



**6" Daisy Round-2**

- ✱ **Stainless Steel Grating**  
GSS-DR
- **Stainless Steel Collar**  
S3/SF-CSS-R





# 6" & 4" Grating & Collar

## Daisy



**6" Daisy Round-2**  
c/w Washing Machine Hose Opening + SS Plug

-  **Stainless Steel Grating**  
GSS-DR-32SSP
-  **Stainless Steel Collar**  
S3/SF-CSS-R



**4" Daisy-1**

-  **Stainless Steel Grating**  
S1-GSS-D
-  **Standard Plastic Collar**  
S3/SF-CP4-G (Grey)  
S3/SF-CP4-W (White)



**4" Daisy-1**  
c/w Washing Machine Hose Opening + SS Plug

-  **Stainless Steel Grating**  
S1-GSS-D-32SSP
-  **Standard Plastic Collar**  
S3/SF-CP4-G (Grey)  
S3/SF-CP4-W (White)



**4" Daisy-1 Anti-Theft**

-  **Stainless Steel Grating**  
S1-GSS-D-AT
-  **Standard Plastic Collar**  
S3/SF-CP4-G (Grey)  
S3/SF-CP4-W (White)

# 6" Grating & Collar

## Venus



**6" Venus Square-2**

-  **Stainless Steel Grating**  
GSS-VS
-  **Standard Plastic Collar**  
S3/SF-CP-6SS-G (Grey)  
S3/SF-CP-6SS-W (White)
-  **360° Aligning Collar**  
S3/SF-ACP-6SS-G (Grey)  
S3/SF-ACP-6SS-W (White)



**6" Venus Square-2**  
c/w Washing Machine Hose Opening + SS Plug

-  **Stainless Steel Grating**  
GSS-VS-32SSP
-  **Standard Plastic Collar**  
S3/SF-CP-6SS-G (Grey)  
S3/SF-CP-6SS-W (White)
-  **360° Aligning Collar**  
S3/SF-ACP-6SS-G (Grey)  
S3/SF-ACP-6SS-W (White)



**6" Venus Square-2 Anti-Theft**

-  **Stainless Steel Grating**  
GSS-VS-AT
-  **Standard Plastic Collar**  
S3/SF-CP-6SS-G (Grey)  
S3/SF-CP-6SS-W (White)
-  **360° Aligning Collar**  
S3/SF-ACP-6SS-G (Grey)  
S3/SF-ACP-6SS-W (White)

\*2 nos Cross Head SS Screws Included



**6" Venus Square-4**

-  **Stainless Steel Grating**  
GSS-VS4
-  **Stainless Steel Collar**  
S3/SF-CSS-S



**6" Venus Square-4**  
c/w Washing Machine Hose Opening + SS Plug

-  **Stainless Steel Grating**  
GSS-VS4-32SSP
-  **Stainless Steel Collar**  
S3/SF-CSS-S





**6" Venus Square-4 Anti-Theft**

-  **Stainless Steel Grating**  
GSS-VS4-AT
-  **Stainless Steel Collar**  
S3/SF-CSS-S-AT

\*2 nos Allen Key SS Screws Included





**6" Venus Square-3**

-  **Stainless Steel Grating**  
GSS-VS3
-  **Standard Plastic Collar with SS Lining**  
S3/SF-CPSSL-G (Grey)  
S3/SF-CPSSL-W (White)
-  **360° Aligning Collar**  
S3/SF-ACPSSL-G (Grey)  
S3/SF-ACPSSL-W (White)





**6" Venus Square-3**  
c/w Washing Machine Hose Opening + SS Plug

-  **Stainless Steel Grating**  
GSS-VS3-32SSP
-  **Standard Plastic Collar with SS Lining**  
S3/SF-CPSSL-G (Grey)  
S3/SF-CPSSL-W (White)
-  **360° Aligning Collar**  
S3/SF-ACPSSL-G (Grey)  
S3/SF-ACPSSL-W (White)



**6" Venus Round-2**

-  **Stainless Steel Grating**  
GSS-VR
-  **Stainless Steel Collar**  
S3/SF-CSS-R

# 6" Grating & Collar

## Venus



### 6" Venus Round-2

c/w Washing Machine Hose Opening + SS Plug

- Stainless Steel Grating**  
GSS-VR-32SSP
- Stainless Steel Collar**  
S3/SF-CSS-R

## Square



### 6" Square

- Stainless Steel Grating**  
GSS-SQ
- Stainless Steel Collar**  
S3/SF-CSS-S



### 6" Square

c/w Washing Machine Hose Opening + SS Plug

- Stainless Steel Grating**  
GSS-SQ-32SSP
- Stainless Steel Collar**  
S3/SF-CSS-S

## Moon



### 6" Moon

- Stainless Steel Grating**  
GSS-MN
- Stainless Steel Collar**  
S3/SF-CSS-R



### 6" Moon

c/w Washing Machine Hose Opening + SS Plug

- Stainless Steel Grating**  
GSS-MN-32SSP
- Stainless Steel Collar**  
S3/SF-CSS-R





# 6" Grating & Collar

## Bamboo





**6" Bamboo-2**

-  **Stainless Steel Grating**  
GSS-BB
-  **Standard Plastic Collar**  
S3/SF-CP-6SS-G (Grey)  
S3/SF-CP-6SS-W (White)
-  **360° Aligning Collar**  
S3/SF-ACP-6SS-G (Grey)  
S3/SF-ACP-6SS-W (White)





\*2 nos Cross Head SS Screws Included

**6" Bamboo-2 Anti-Theft**

-  **Stainless Steel Grating**  
GSS-BB-AT
-  **Standard Plastic Collar**  
S3/SF-CP-6SS-G (Grey)  
S3/SF-CP-6SS-W (White)
-  **360° Aligning Collar**  
S3/SF-ACP-6SS-G (Grey)  
S3/SF-ACP-6SS-W (White)



**6" Bamboo-3**

-  **Stainless Steel Grating**  
GSS-BB3
-  **Standard Plastic Collar with SS Lining**  
S3/SF-CPSSL-G (Grey)  
S3/SF-CPSSL-W (White)
-  **360° Aligning Collar**  
S3/SF-ACPSSL-G (Grey)  
S3/SF-ACPSSL-W (White)



**6" Bamboo-4**

-  **Stainless Steel Grating**  
GSS-BB4
-  **Stainless Steel Collar**  
S3/SF-CSS-S



\*2 nos Allen Key SS Screws Included

**6" Bamboo-4 Anti-Theft**

-  **Stainless Steel Grating**  
GSS-BB4-AT
-  **Stainless Steel Collar**  
S3/SF-CSS-S-AT

# 6" Grating & Collar

## Diamond



**6" Diamond Square-2**

- **Stainless Steel Grating**  
GSS-DMS
- **Standard Plastic Collar**  
S3/SF-CP-6SS-G (Grey)  
S3/SF-CP-6SS-W (White)
- **360° Aligning Collar**  
S3/SF-ACP-6SS-G (Grey)  
S3/SF-ACP-6SS-W (White)



**6" Diamond Square-2 Anti-Theft**

- **Stainless Steel Grating**  
GSS-DMS-AT
- **Standard Plastic Collar**  
S3/SF-CP-6SS-G (Grey)  
S3/SF-CP-6SS-W (White)
- **360° Aligning Collar**  
S3/SF-ACP-6SS-G (Grey)  
S3/SF-ACP-6SS-W (White)



**6" Diamond Square-3**

- **Stainless Steel Grating**  
GSS-DMS3
- **Standard Plastic Collar with SS Lining**  
S3/SF-CPSSL-6SS-G (Grey)  
S3/SF-CPSSL-6SS-W (White)
- **360° Aligning Collar**  
S3/SF-ACPSSL-G (Grey)  
S3/SF-ACPSSL-W (White)



**6" Diamond Round-2**

- **Stainless Steel Grating**  
GSS-DMR
- **Stainless Steel Collar**  
S3/SF-CSS-R



**6" Diamond Square-4**

- **Stainless Steel Grating**  
GSS-DMS4
- **Stainless Steel Collar**  
S3/SF-CSS-S



**6" Diamond Square-4 Anti-Theft**

- **Stainless Steel Grating**  
GSS-DMS4-AT
- **Stainless Steel Collar**  
S3/SF-CSS-S-AT

# 6" & 4" Grating & Collar

## Chess



**6" Chess Square-2**

- **Stainless Steel Grating**  
GSS-CHS
- **Standard Plastic Collar**  
S3/SF-CP-6SS-G (Grey)  
S3/SF-CP-6SS-W (White)
- **360° Aligning Collar**  
S3/SF-ACP-6SS-G (Grey)  
S3/SF-ACP-6SS-W (White)



**6" Chess Square-2 Anti-Theft**

- **Stainless Steel Grating**  
GSS-CHS-AT
- **Standard Plastic Collar**  
S3/SF-CP-6SS-G (Grey)  
S3/SF-CP-6SS-W (White)
- **360° Aligning Collar**  
S3/SF-ACP-6SS-G (Grey)  
S3/SF-ACP-6SS-W (White)



**6" Chess Square-3**

- **Stainless Steel Grating**  
GSS-CHS3
- **Standard Plastic Collar with SS Lining**  
S3/SF-CPSSL-6SS-G (Grey)  
S3/SF-CPSSL-6SS-W (White)
- **360° Aligning Collar**  
S3/SF-ACPSSL-G (Grey)  
S3/SF-ACPSSL-W (White)



**6" Chess Round-2**

- **Stainless Steel Grating**  
GSS-CHR
- **Stainless Steel Collar**  
S3/SF-CSS-R



**6" Chess Square-4**

- **Stainless Steel Grating**  
GSS-CHS4
- **Stainless Steel Collar**  
S3/SF-CSS-S



**6" Chess Square-4 Anti-Theft**

- **Stainless Steel Grating**  
GSS-CHS4-AT
- **Stainless Steel Collar**  
S3/SF-CSS-S-AT

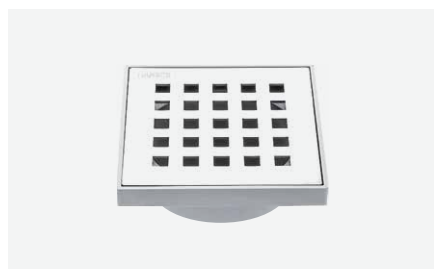

**4" Chess-1**

- **Stainless Steel Grating**  
S1-GSS-C
- **Standard Plastic Collar**  
S3/SF-CP4-G (Grey)  
S3/SF-CP4-W (White)

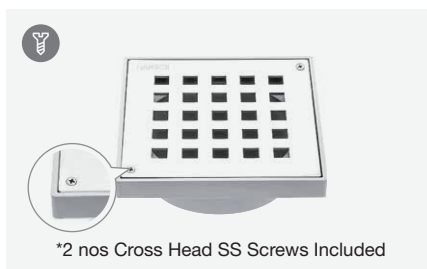

**4" Chess-1 Anti-Theft**

- **Stainless Steel Grating**  
S1-GSS-C-AT
- **Standard Plastic Collar**  
S3/SF-CP4-G (Grey)  
S3/SF-CP4-W (White)





# 6" Grating & Collar

## Chequer





**6" Chequer Square-2**

-  **Stainless Steel Grating**  
GSS-CQS
-  **Standard Plastic Collar**  
S3/SF-CP-6SS-G (Grey)  
S3/SF-CP-6SS-W (White)
-  **360° Aligning Collar**  
S3/SF-ACP-6SS-G (Grey)  
S3/SF-ACP-6SS-W (White)





**6" Chequer Square-2 Anti-Theft**

-  **Stainless Steel Grating**  
GSS-CQS-AT
-  **Standard Plastic Collar**  
S3/SF-CP-6SS-G (Grey)  
S3/SF-CP-6SS-W (White)
-  **360° Aligning Collar**  
S3/SF-ACP-6SS-G (Grey)  
S3/SF-ACP-6SS-W (White)





**6" Chequer Square-3**

-  **Stainless Steel Grating**  
GSS-CQS3
-  **Standard Plastic Collar with SS Lining**  
S3/SF-CPSSL-6SS-G (Grey)  
S3/SF-CPSSL-6SS-W (White)
-  **360° Aligning Collar**  
S3/SF-ACPSSL-G (Grey)  
S3/SF-ACPSSL-W (White)





**6" Chequer Round-2**

-  **Stainless Steel Grating**  
GSS-CQR
-  **Stainless Steel Collar**  
S3/SF-CSS-R





**6" Chequer Square-4**

-  **Stainless Steel Grating**  
GSS-CQS4
-  **Stainless Steel Collar**  
S3/SF-CSS-S



**6" Chequer Square-4 Anti-Theft**

-  **Stainless Steel Grating**  
GSS-CQS4-AT
-  **Stainless Steel Collar**  
S3/SF-CSS-S-AT

# S4

## Installation Method

Recommended slab thickness 125mm and above.

**Step 1:** Nail the trap body to form work, connect the drain pipes or air-cond discharge pipes if any.

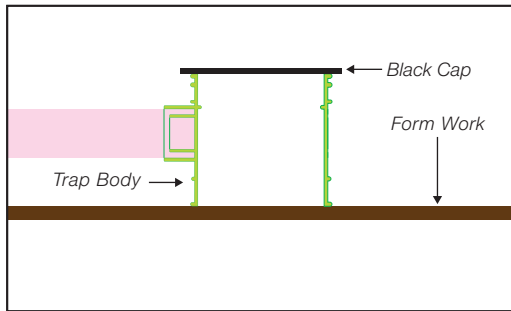

**Step 2:** Remove form work, fix outlet (with solvent cement).

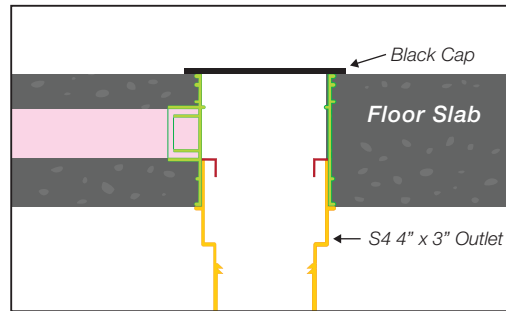

**Step 3:** Join bend or tee (with solvent cement) and fix uPVC pipe

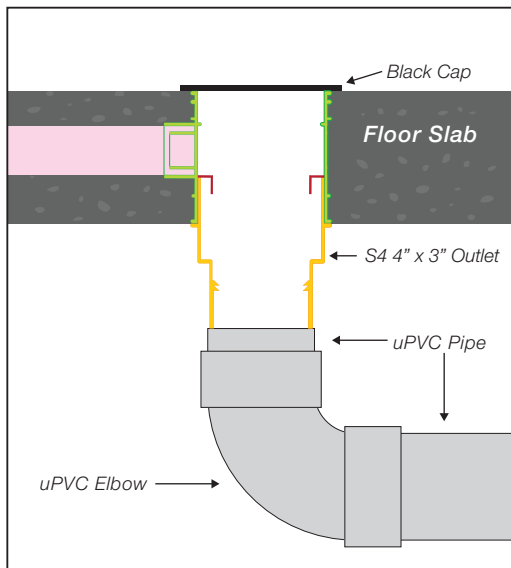

**Step 4:** Remove black cap (cover), join 4" uPVC pipe to top of the trap body. Water proof and screed.

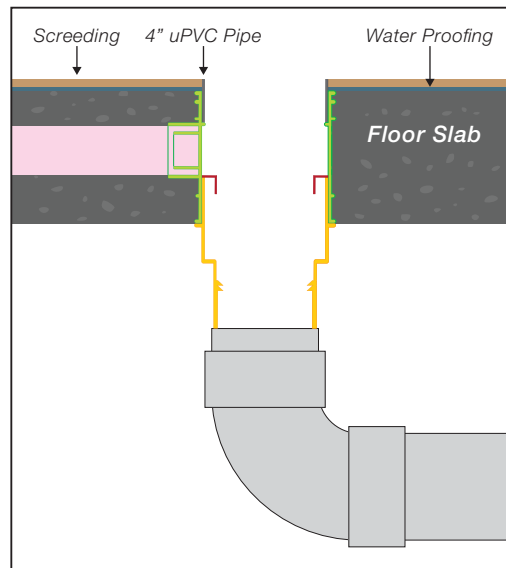

**Step 5:** Place collar and flush with tile work.

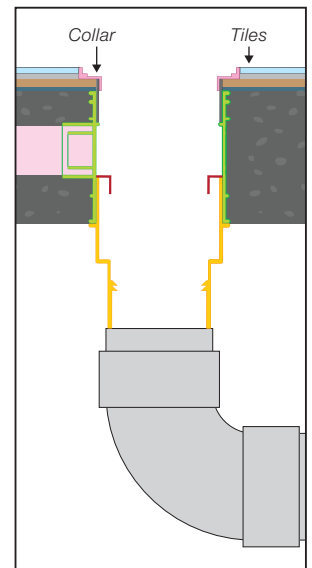

**Step 6:** Place bucket trap.

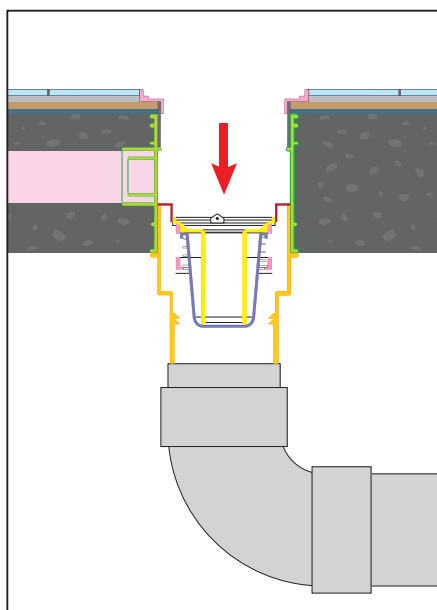

**Step 7:** Place grating.  
Installation completed.

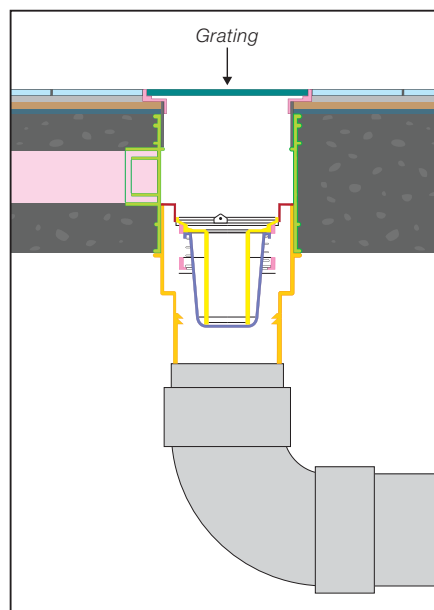

It is recommended to use the black cap cover during installation and concreting.

# Schematic Layout

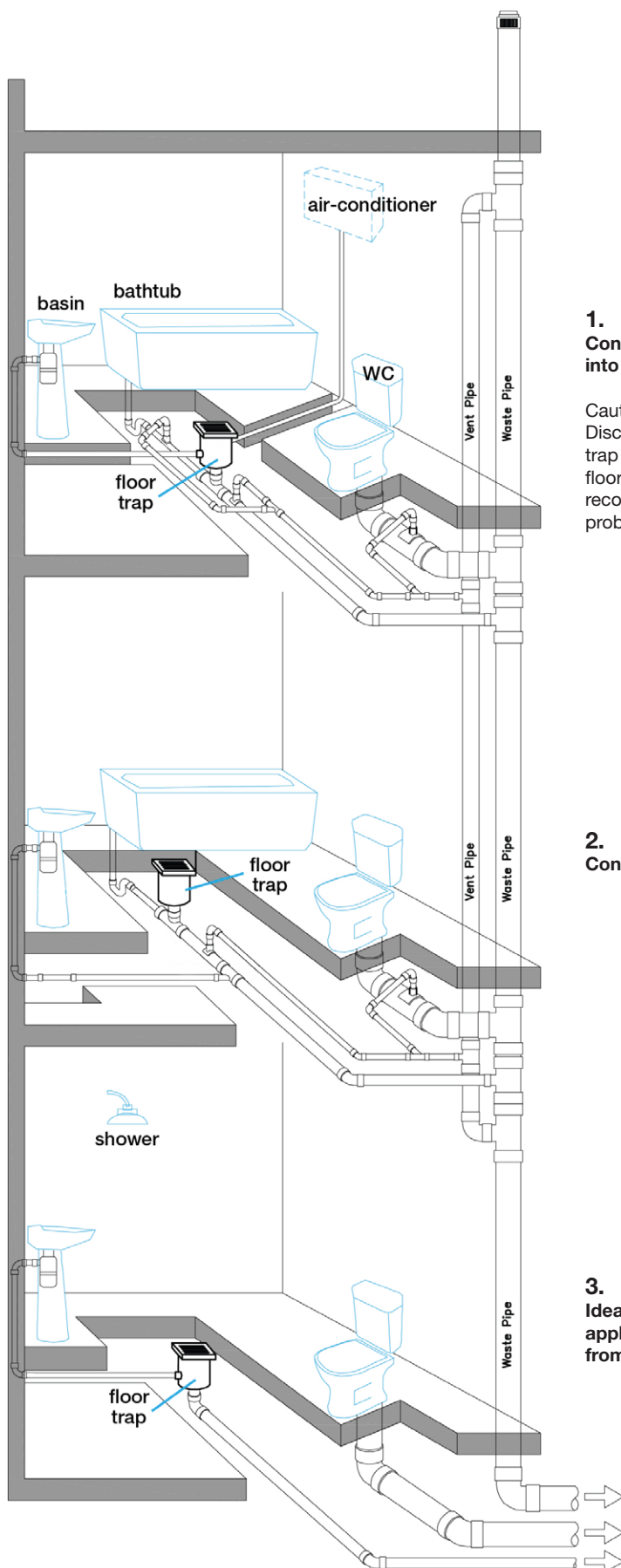

**1. Connection of basin & air-cond pipe into trap body**

Caution:  
Discharge of air-cond pipe into floor trap may cause condensation on the floor trap base. Insulation is recommended to prevent the problem.

**2. Connection of basin below trap.**

**3. Ideal solution for ground floor applications, to allow servicing from top.**

Discharge to inspection chamber

## 360° Aligning Collar



# Another Innovative product from us.

With the many obvious benefits, advantages and increasing popularity of in-slab floor traps, there is an increasing need to have easy and uninterrupted access to the inside of these traps for maintenance purposes.

Towards this end, Sansico™ has patented an **ingenious floor trap collar system** that gives unlimited and full access to the floor trap. The opening size is even larger than the trap itself, this provides easy access for maintenance and repair.

The central part of this collar is rotatable and allows for a misalignment up to 20mm (in any direction) in the collar placing, this can sometimes happen during tiling.

**Usage of this collar eliminates all problems associated with access to floor traps for maintenance.**

A great value item, makes life easier for the end user.

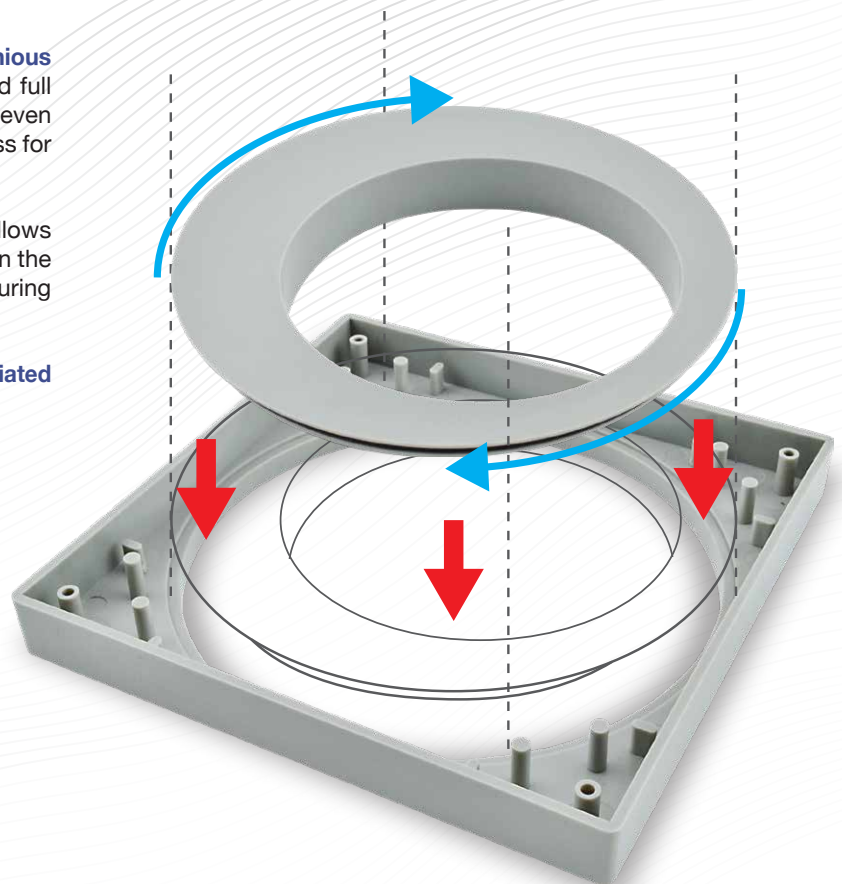

## Installation Method

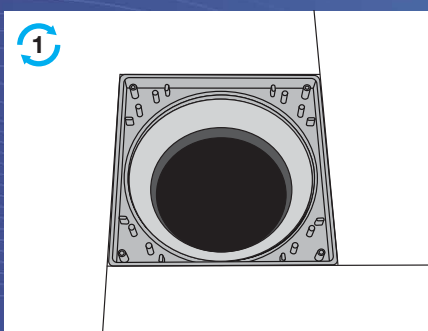

1 Install collar frame.

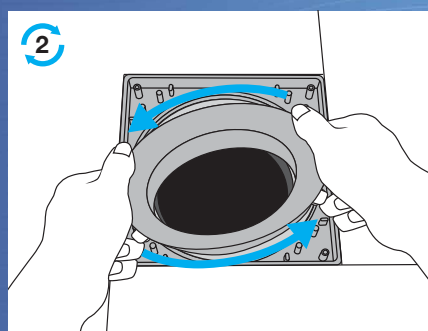

2 Adjust position by using adjustable collar insert.

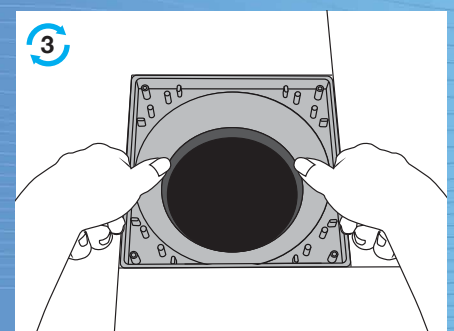

3 Push the collar insert into collar frame.







The logo for SANSICO, featuring the word "SANSICO" in white, bold, uppercase letters inside a dark blue rounded rectangular box. A small "SM" trademark symbol is located at the top right of the box.

**SANSICO**<sup>SM</sup>

The logo for HANSEN, featuring the word "HANSEN" in white, bold, uppercase letters inside a dark blue rounded rectangular box. A small "SM" trademark symbol is located at the top right of the box.

**HANSEN**<sup>SM</sup>

**Sansico Industries Sdn Bhd** (448766-D)

No. 20, Jalan Uranus AK U5/AK,  
Taman Subang Impian, Seksyen U5,  
40150 Shah Alam, Selangor.

---

Tel : (603) 7859 7299 (**Hunting Line**)

Fax : (603) 7859 0299

E-mail : [enquiry@sansico.com.my](mailto:enquiry@sansico.com.my)

Website : [www.sansico.com.my](http://www.sansico.com.my)